

INSTALLATION OPERATION INSTRUCTION



PLC LIGHTING
CHATSWORTH, CA

MODEL NO.: 21062

PREPARING THE FIXTURE

- * BEFORE STARTING THE INSTALLATION, DISCONNECT THE POWER BY TURNING OFF THE CIRCUIT BREAKER. TURNING THE POWER OFF BY USING THE LIGHT SWITCH IS NOT SUFFICIENT TO PREVENT ELECTRICAL SHOCK
- * IF YOU ARE REPLACING AN EXISTING FIXTURE, DISCONNECT AND REMOVE THE OLD FIXTURE. EXPOSE THE SUPPLY WIRING FROM THE SUPPLY CIRCUIT

WARNING - RISK OF FIRE AND ELECTRIC SHOCK. THIS PRODUCT IS TO BE INSTALLED BY A QUALIFIED ELECTRICIAN ONLY

FOR SUPPLY CONNECTIONS, USE WIRE RATED AT LEAST 90 C DEGREE

* PLEASE FOLLOW THE STEPS FOR INSTALL *

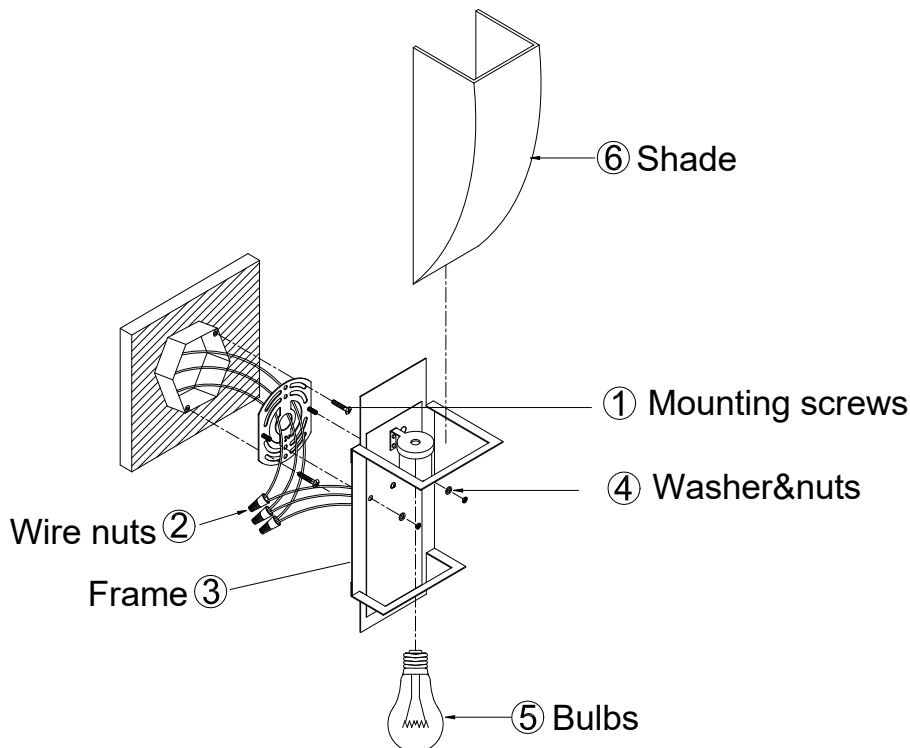

- * THE DISTANCE SHALL BE KEPT MORE THAN 15CM FROM THE BULB TO THE LIGHTED OBJECT.
- * CONSULT A QUALIFIED ELECTRICIAN TO ENSURE CORRECT BRANCH CIRCUIT CONDUCTOR.
CONSULTER UN ELEXTRICIEEN QUALIFIE POUR VOUS ASSURER QUE LES CONDUCTEURS DE LA DERIVATION SONT ADEQUATS.
- * THIS PRODUCT MUST BE INSTALLED IN ACCORDANCE WITH THE APPLICABLE INSTALLATION CODE BY A PERSON FAMILIAR WITH THE CONSTRUCTION AND OPERATION OF THE PRODUCT AND THE HAZARDS INVOLVED.
CE PRODUIT DOIT ETRE INSTALLE SELON LE CODE D'INSTALLATION PERTINENT, PAR UNE PERSONNE QUI CONNAIT BIEN LW PRODUIT ET SON FONCTIONNEMENT AINSI QUE LES RISQUES INHERENTS.

PLEASE ENSURE "NEVER INSTALL THE FIXTURE TO THE WALL OUTLET BOX, WHICH CAN'T BE COVERED BY THE CANOPY"